



Contents lists available at ScienceDirect

Physica C

journal homepage: [www.elsevier.com/locate/physc](http://www.elsevier.com/locate/physc)

## Progress in high-linearity multi-element Josephson structures

Victor Kornev<sup>a,\*</sup>, Igor Soloviev<sup>a</sup>, Nikolai Klenov<sup>a</sup>, Oleg Mukhanov<sup>b</sup>

<sup>a</sup> Physics Department, Moscow State University, 119992 Moscow, Russia

<sup>b</sup> HYPRES, Inc., 175 Clearbrook Road, Elmsford, NY 10523, USA

### ARTICLE INFO

#### Article history:

Available online xxxxx

#### Keywords:

Josephson junction  
dc SQUID  
Array structure  
Dynamic range  
Linear voltage response  
Bi-SQUID

### ABSTRACT

This paper summarizes both theoretical and experimental studies aimed at synthesis of high-linearity multi-element Josephson structures. Both the dynamic range and the voltage response linearity are two conjugated characteristics that must be improved jointly. Increase in dynamic range is reasonably associated with increase of number of elements  $N$  in the Josephson-junction structures. To improve the voltage response linearity one can use special design of the array structures. The other way is based on use novel basic cell with is bi-SQUID capable of providing highly linear voltage response. Both the approaches were used in designs of the reported high-linearity multi-element Josephson structures.

© 2010 Elsevier B.V. All rights reserved.

### 1. Introduction

dc SQUIDs are known and widely used as extremely sensitive amplifiers, but showing only limited linearity voltage response. In conventional low-frequency SQUID systems, the improved linearity and dynamic range are obtained by using an external feedback loop which has limited bandwidth. Such an external feedback approach is unfeasible in case one needs to design a SQUID-based system with very broad bandwidth. A solution may be found by using Josephson-junction array structures which could provide the increase in dynamic range with number of elements  $N$ . As for the voltage response linearity increase, two different approaches can be suggested. The first one is based on use of special design of the structures, and the second approach consists in invention of a novel dc SQUID capable of providing highly linear voltage response.

In this paper, we present theoretical and experimental results achieved for the two approaches to synthesis of the high linearity array structures.

### 2. Differential scheme of two parallel SQIFs

Recently we have proposed Josephson-junction structures capable of providing a SQIF-like (Superconducting Quantum Interference Filter) high linearity voltage response [1]. The structures are based on the use of a differential scheme (see Fig. 1) of two magnetically frustrated parallel SQIFs with special distribution  $a(x)$  of

the cell areas along the array and critical current biasing  $I_b = (I_c)_{\text{SQIF}}$ . We found the normalized cell area distribution

$$a(x)/a_{\Sigma} = 1.2 - 0.48 \sin^3(\pi x), \quad (1)$$

(here  $a_{\Sigma}$  is total area of SQIF) which allows providing the response linearity up to 100 dB at vanishing inductances  $l$  between junctions.

Unfortunately finite (non-zero) value of the coupling inductances  $l$  has fundamental importance for all principal characteristics of the parallel array, since it imposes limitations on coupling radius as shown in Fig. 2.

The increase in dynamic range is limited by the coupling radius value at signal frequency ( $\omega < 0.1$ ) whereas the radius value at Josephson oscillation frequency ( $\omega \sim 1$ ) severely limits the effective number  $N_{\text{eff}}$  of the junctions which take part in the voltage response formation. One can shunt the coupling inductances by low-ohmic resistors to provide some increase in the coupling radius and hence in the number  $N_{\text{eff}}$  [2]. As for dynamic range  $D$ , the required value of  $D$  can be achieved by serial connection of an appropriate number of the parallel-SQIF circuits.

We designed and fabricated a two-dimensional structure using a 4.5 kA/cm<sup>2</sup> Nb HYPRES process [3]. This is a differential circuit of two magnetically frustrated serial arrays of 10 parallel SQIFs each containing 10 Josephson junctions. Low-ohmic resistors shunting coupling inductances were used to increase the described above effective number  $N_{\text{eff}}$  up to about 10. The standard design and fabrication of serial arrays with two superconducting ground planes lead to the high enough stray capacitances. In order to decrease impact of the stray capacitances which are characteristic for the standard designs with two superconducting ground planes, we used individual double ground plane sections for each SQIF of the serial array [2].

\* Corresponding author. Tel.: +7 495 939 4351; fax: +7 495 939 3000.  
E-mail address: [kornev@phys.msu.ru](mailto:kornev@phys.msu.ru) (V. Kornev).

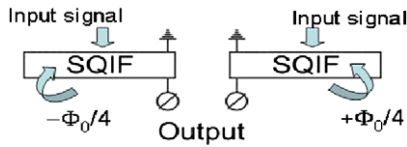

Fig. 1. Differential scheme of two parallel SQIFs frustrated by  $\Phi_0/2$ .

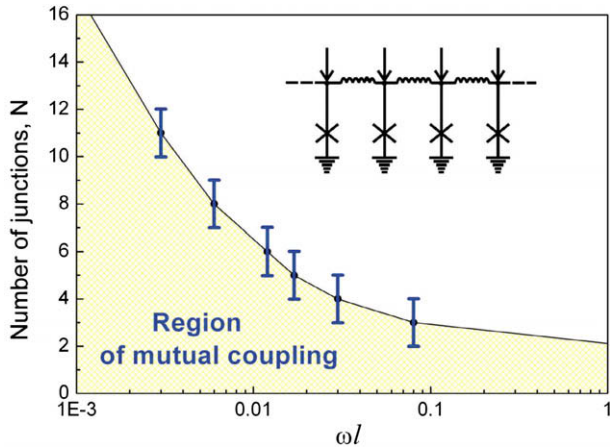

Fig. 2. Josephson-junction coupling radius for parallel array versus impedance of the coupling inductances used.

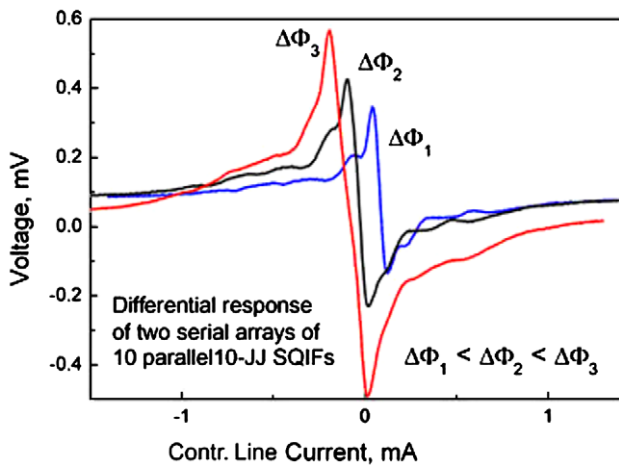

Fig. 3. The measured by automated setup OCTOPUX [4] differential voltage responses of two magnetically frustrated serial arrays of 10 parallel SQIFs each containing 10 Josephson junctions at different magnetic frustrations  $\Delta\Phi_1$ ,  $\Delta\Phi_2$  and  $\Delta\Phi_3$ . The response corresponding to  $\Delta\Phi_1$  is shifted (along horizontal axis) for clearness.

Fig. 3 presents the experimentally observed differential voltage responses corresponding to different magnetic frustrations  $\Delta\Phi_1$ ,  $\Delta\Phi_2$ ,  $\Delta\Phi_3$  of the serial arrays of SQIFs. The measured characteristics are in full correspondence with the ones obtained by numerical simulation.

### 3. Bi-SQUID

We modified conventional dc SQUID by adding a nonlinear inductive element shunting the linear inductance of the loop coupling RF magnetic flux into the SQUID (see Fig. 4a). The nonlinear inductive element is a Josephson junction that remains in its

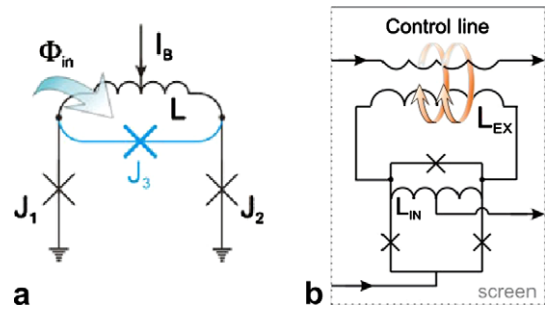

Fig. 4. Bi-SQUID (a) and equivalent circuit of bi-SQUID with an additional transformer loop coupled to a control stripline for magnetic flux application (b).

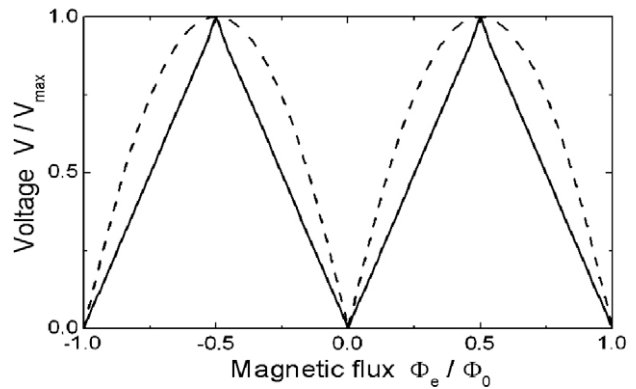

Fig. 5. Voltage response (numerical simulation) of conventional dc SQUID (dash line) and bi-SQUID (solid line) with normalized inductance  $l = 1$  at bias current  $I_b = 2I_c$  and  $I_{c3} = 1.1I_c$ .

superconductive state during operation. This nonlinear element modifies the nonlinear transfer function of the SQUID to produce higher linearity transfer function, thus increasing the utility of the device as a linear amplifier. The nonlinear small-signal shunt inductance is the Josephson-junction inductance

$$L_J = \Phi_0 \left( 2\pi I_{c3} \sqrt{1 - i^2} \right)^{-1}, \quad (2)$$

where  $i = I_{sh}/I_{c3}$  is the normalized current passing through the shunt junction. The effective loop inductance is a parallel combination of the main inductance  $L$  and the Josephson inductance  $L_J$ . The additional junction and main inductance form a single-junction SQUID. In such a way, the modified dc SQUID can be called as *bi-SQUID*. Fig. 5 shows the voltage response of both the conventional dc SQUID (dash line) and bi-SQUID (solid line) with normalized inductance  $l = 2\pi I_c L / \Phi_0 = 1$  at bias current  $I_b = 2I_c$ , and  $I_{c3} = 1.15I_c$ . This shows a triangular transfer function where the triangle edges are quite straight. Such a device implementation makes use of a Josephson junction as a nonlinear inductive element that can largely compensate the nonlinearity associated with the conventional SQUID transfer function.

#### 3.1. Voltage response linearity

The dc SQUID, modified by adding a Josephson junction shunting the loop inductance, provides extremely high linearity with the proper selection of parameters. This is somewhat surprising, since a Josephson junction is a nonlinear inductance. However, the junction nonlinearity is able to compensate the nonlinearity of the device in order to achieve an improved linearity close to 120 dB for significant loop inductances (which are necessary to achieve large coupling to external signals). One can note that other Josephson

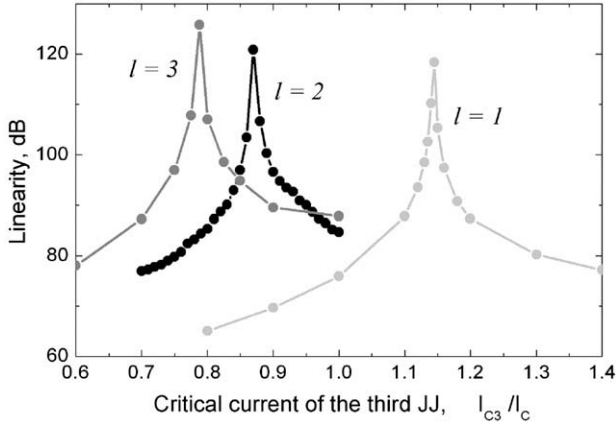

**Fig. 6.** Dependence of the bi-SQUID voltage response linearity on critical current of the shunt junction for several fixed values of normalized loop inductance  $l$  at bias current  $I_b = 2I_c$ .

nonlinear reactance that functions in a similar way would have a similar effect on reducing the transfer function nonlinearity of more complex Josephson systems.

The linearity dependence on the shunt junction  $I_{c3}$  on critical current at different inductances of the bi-SQUID loop is shown in Fig. 6. The linearity is calculated using a single-tone sinusoidal flux input (of amplitude  $A/A_{\max} = 0.2$ , where  $A_{\max}$  corresponds to the flux amplitude  $\Phi_0/4$ ), and measuring the total harmonic distortion in dB. This result shows that the linearity is sharply peaked for each value of  $l$ , but with different optimized values of  $I_{c3}$ . Very large values of linearity as high as  $\sim 120$  dB are achievable.

### 3.2. Analytical theory

We performed analytical study of such a symmetric bi-SQUID in the frame of RSJ model of overdamped Josephson junctions. It is more convenient to use the sum phase  $\theta = \phi_2 + \phi_1$  and the differential phase  $\psi = \phi_2 - \phi_1$  instead of the phases  $\phi_1$  and  $\phi_2$  of the basic Josephson junctions. In resistive state, the sum phase  $\theta$  is the running one while the differential phase  $\psi$  is a bounded function which may be represented as a sum of the slow-varying (signal) phase  $\tilde{\psi}$  depending on applied magnetic flux  $\varphi_e$  and the oscillating phase  $\tilde{\psi}$ .

In case of bi-SQUID, one can consider the oscillating phase difference  $\tilde{\psi}$  as a small term. Due to the shunt junction, the term  $\tilde{\psi}$  remains small at quite practical inductance parameter  $l \sim 1$  (this fact is proved by numerical simulations). Therefore we may apply method of successive approximations for the equation solution and use the series distributions for  $\theta$  and  $\psi$  as follows:

$$\theta = \theta_0 + \theta_1 + \dots, \quad \psi = \psi_0 + \psi_1 + \dots,$$

To a first approximation corresponding to  $\theta \approx \theta_0$ ,  $\psi \approx \tilde{\psi} \approx \psi_0$  when small term  $\tilde{\psi}$  is neglected, after averaging over Josephson oscillations we come finally to the following set of two equations:

$$v = \frac{1}{2} \langle \dot{\theta}_0 \rangle = \sqrt{\frac{i_b^2}{4} - \cos^2\left(\frac{\psi_0}{2}\right)}. \quad (3)$$

$$li_{c3} \sin(\psi_0) + \psi_0 = -\varphi_e, \quad (4)$$

The first term in (4) setting nonlinear relation between applied magnetic flux and differential phase  $\psi_0$  is just the term responsible for linearization of the bi-SQUID transfer function  $\mathcal{U}(\varphi_e)$ . The obtained set of equations (3) and (4) gives voltage response (transfer function) of bi-SQUID  $\mathcal{U}(\varphi_e)$  as an implicit function.

Despite the fact that the developed analytical theory is strictly valid at strong inequality  $\tilde{\psi} \ll \pi/2$ , and in case of weak inequality

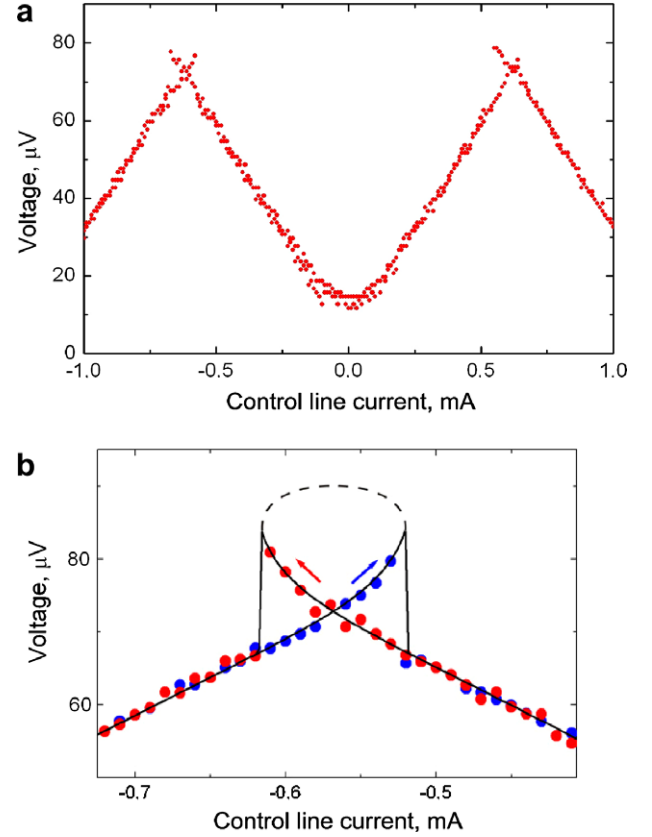

**Fig. 7.** (a) The measured by OCTOPUX [4] voltage response of bi-SQUID with equal critical currents of all junctions and inductive parameter  $l = 1.4$ . (b) Top part of the response and the fit curve. Unstable part of the top loop is shown by dash line.

Eqs. (3) and (4) should be considered only as a first approximation, the obtained theoretical results are in a good agreement with the results of numerical simulations (by PSCAN [5]) of the bi-SQUID at inductive parameter  $l$  of about 1 and even more.

### 3.3. Experimental study

We designed, fabricated and tested bi-SQUID using a  $4.5 \text{ kA/cm}^2$  Nb HYPRES process [3]. To apply magnetic flux, we used a control stripline coupled magnetically with an additional transformer loop (see equivalent circuit in Fig. 4a). This loop with high inductance  $L_{\text{ex}}$  is connected in parallel to inductance  $L_{\text{in}}$  and therefore practically does not change the interferometer inductance.

Fig. 7 shows the measured voltage response of the bi-SQUID biased by a current slightly more than critical current  $2I_c$ . The shunt junction critical current was not of the optimal value at the implemented inductance parameter. As a result, the observed voltage response is not perfectly linear, although it shows a clear triangular shape. The measured transfer function closely coincides with the one calculated numerically. As for the small hysteresis at the flux value close to  $\pm\Phi_0/2$ , it indicates that effective inductance parameter of a single-junction SQUID  $\tilde{l} \equiv l \cdot i_{c3} \equiv 2\pi L i_{c3} / \Phi_0$  is more than 1 and hence the static phase diagram becomes hysteretic. Fig. 7b shows the top part of the measured voltage response and the fit curve calculated using set of equations (3) and (4).

## 4. Conclusion

Experimentally observed characteristics of the designed and fabricated circuits confirm the proposed design solutions. This is

of critical importance for the further development of the Josephson-junction structures capable of providing high dynamic range and highly linear voltage response.

#### Acknowledgements

This work was supported in part by CRDF Grant RUP1-1493-MO-05, and Russian Grants for Scientific Schools 5408.2008.2 and 133.2008.2.

#### References

- [1] V.K. Kornev, I.I. Soloviev, N.V. Klenov, O.A. Mukhanov, IEEE Trans. Appl. Supercond. 19 (3) (2009) 741.
- [2] V.K. Kornev, I.I. Soloviev, N.V. Klenov, T.V. Filippov, H. Engseth, O.A. Mukhanov, IEEE Trans. Appl. Supercond. 19 (3) (2009) 916.
- [3] <<http://www.hypres.com/>>.
- [4] <<http://gamayun.physics.sunysb.edu/RSFQ/Research/octopus.html>>.
- [5] V.K. Kornev, A.V. Arzumanov, Numerical simulation of Josephson-junction system dynamics in the presence of thermal noise, in: Inst. Physics Conf., Ser. No. 158, IOP Publishing Ltd., 1997, pp. 627–630.